

Bots are fast, humans are smarter

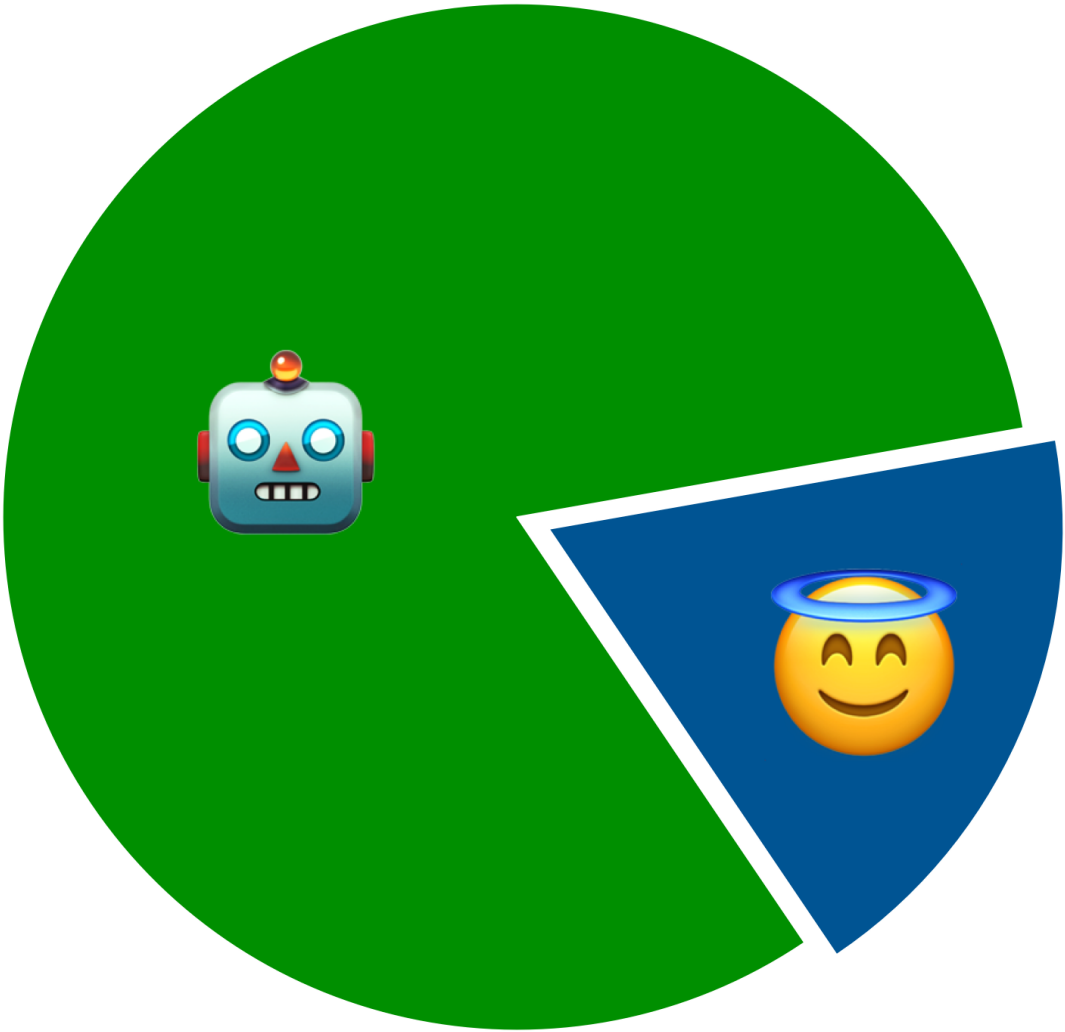

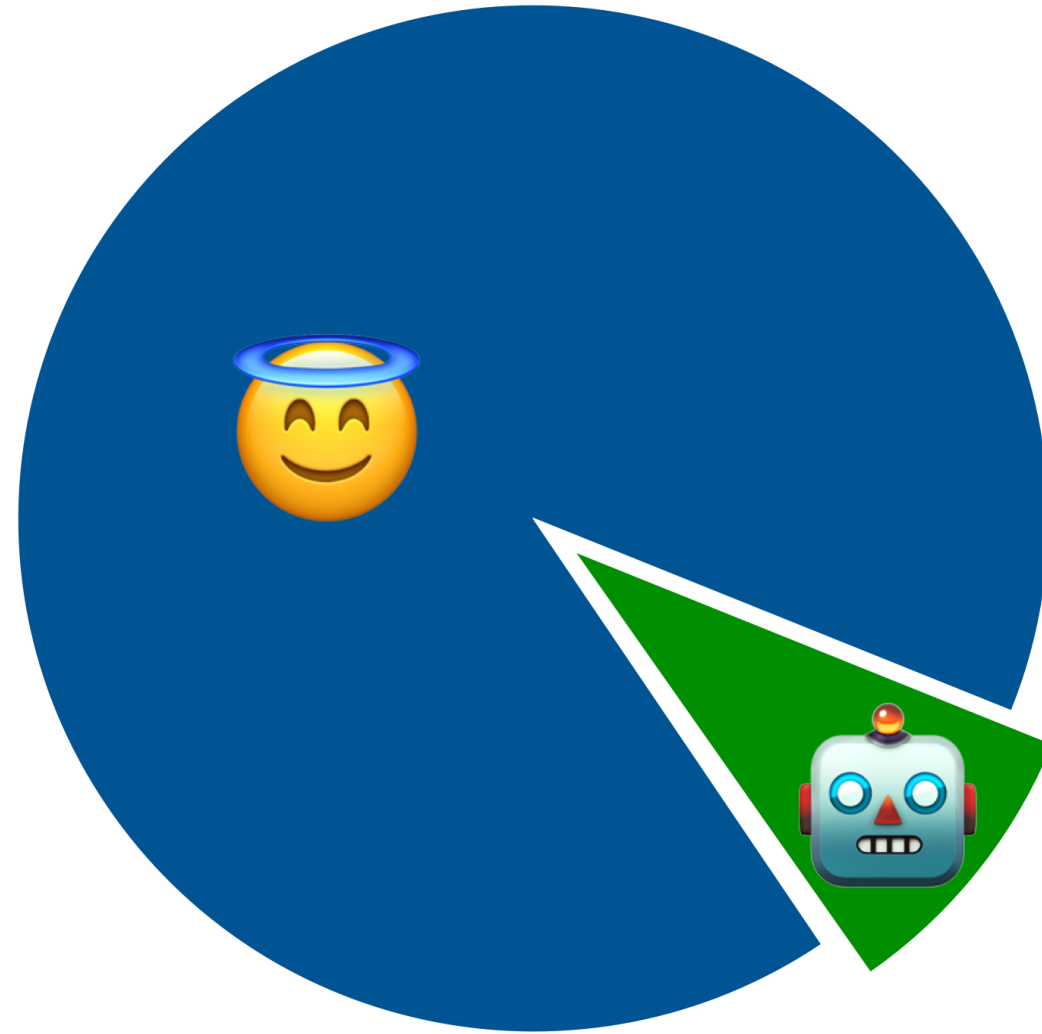

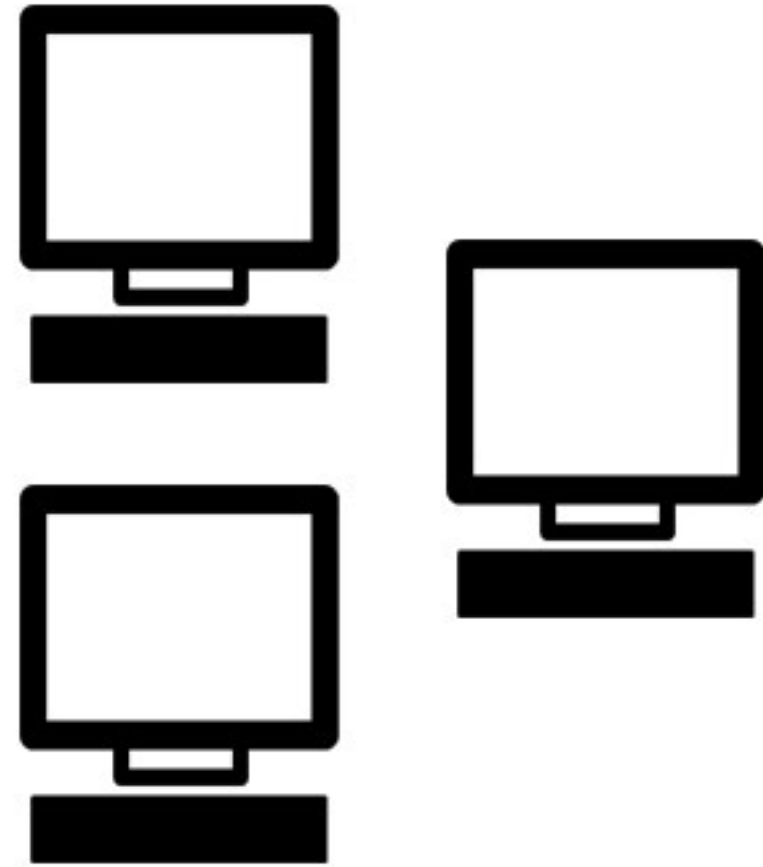
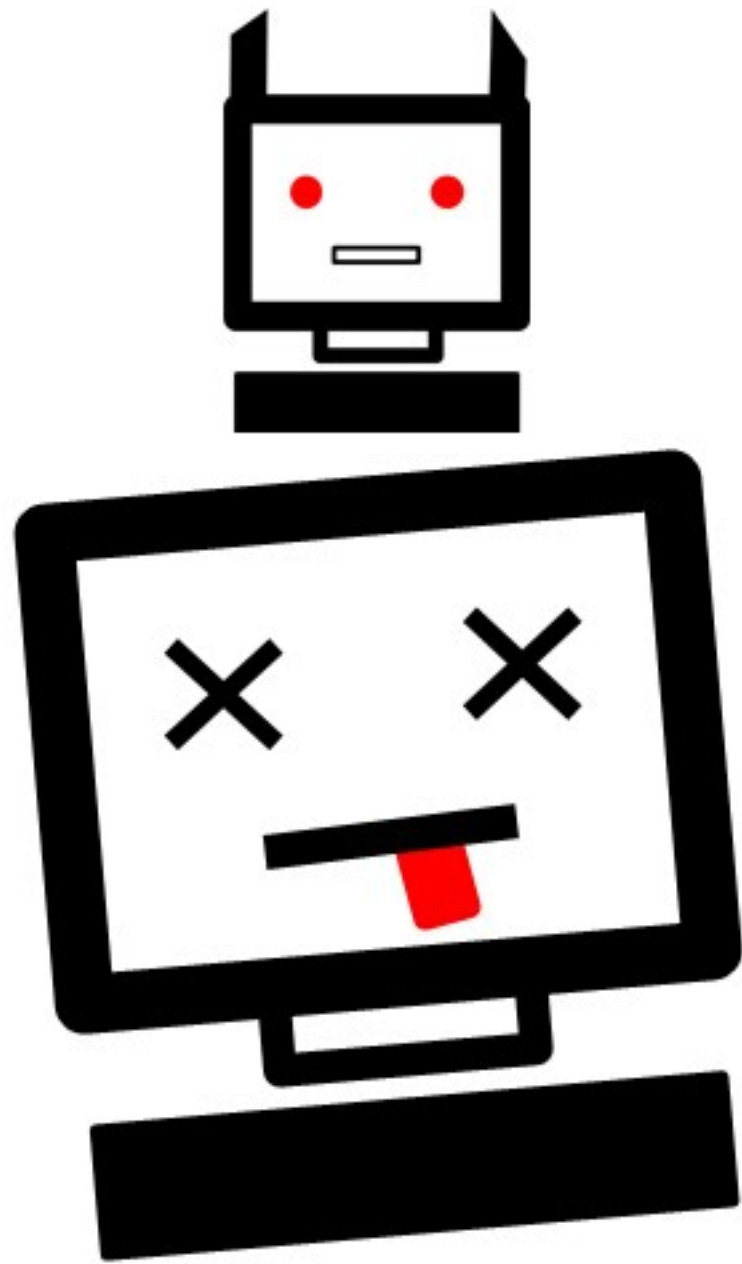

DDoS attack

**DISTRIBUTED
DENIAL OF
SERVICE**

BOTS EXPLAINED





1
NIKE AIR YEEZY 2
RED OCTOBER
\$5,131



2
COLLEGE DROPOUT
NIKE AIR MAX 180
\$4,000



3
NIKE AIR YEEZY 2
SOLAR RED
\$3,972



4
DROPOUT BEAR
BAPESTA
\$3,775



5
NIKE AIR YEEZY 2
PLATINUM
\$3,137



6
ADIDAS YEEZY BOOST
750 LIGHT BROWN
\$2,993



7
LOUIS VUITTON JASPER
PATCHWORK
\$2,800



8
LOUIS VUITTON JASPER
CREAM
\$2,800



9
LOUIS VUITTON JASPER
BLACK
\$2,800



10
LOUIS VUITTON DON
RED
\$2,579



11
LOUIS VUITTON DON
PATCHWORK
\$2,579



12
LOUIS VUITTON DON
CREAM
\$2,579



13
LOUIS VUITTON DON
BLACK
\$2,579



14
NIKE AIR YEEZY 1
ZEN GREY
\$2,141



15
ADIDAS YEEZY BOOST
750 LIGHT GREY
\$2,121



16
NIKE AIR YEEZY 1
NET
\$1,869



17
NIKE AIR YEEZY 1
BLINK
\$1,792



18
ADIDAS YEEZY BOOST
750 TRIPLE BLACK
\$1,627



19
ADIDAS YEEZY BOOST
350 TURTLEDOVE
\$1,571



20
ADIDAS YEEZY BOOST
350 MOONROCK
\$1,167



21
ADIDAS YEEZY BOOST
350 OXFORD TAN
\$1,078



22
ADIDAS YEEZY BOOST
350 PIRATE BLACK (2016)
\$1,064



23
ADIDAS YEEZY BOOST
350 PIRATE BLACK (2015)
\$991



24
LOUIS VUITTON MR.
HUDSON WHITE
N/A



25
LOUIS VUITTON MR.
HUDSN PATCHWORK
N/A

GET READY TO COP THOSE SNEAKERS

This is AIO Bot, an add to cart program that helps sneaker lovers get limited releases.

AIO Bot – by the creators of *Another Nike Bot* – has tons of features and has been market tested to give you the best user experience possible – and the best results.

DISCOVER THE FEATURES

FOLLOW US:

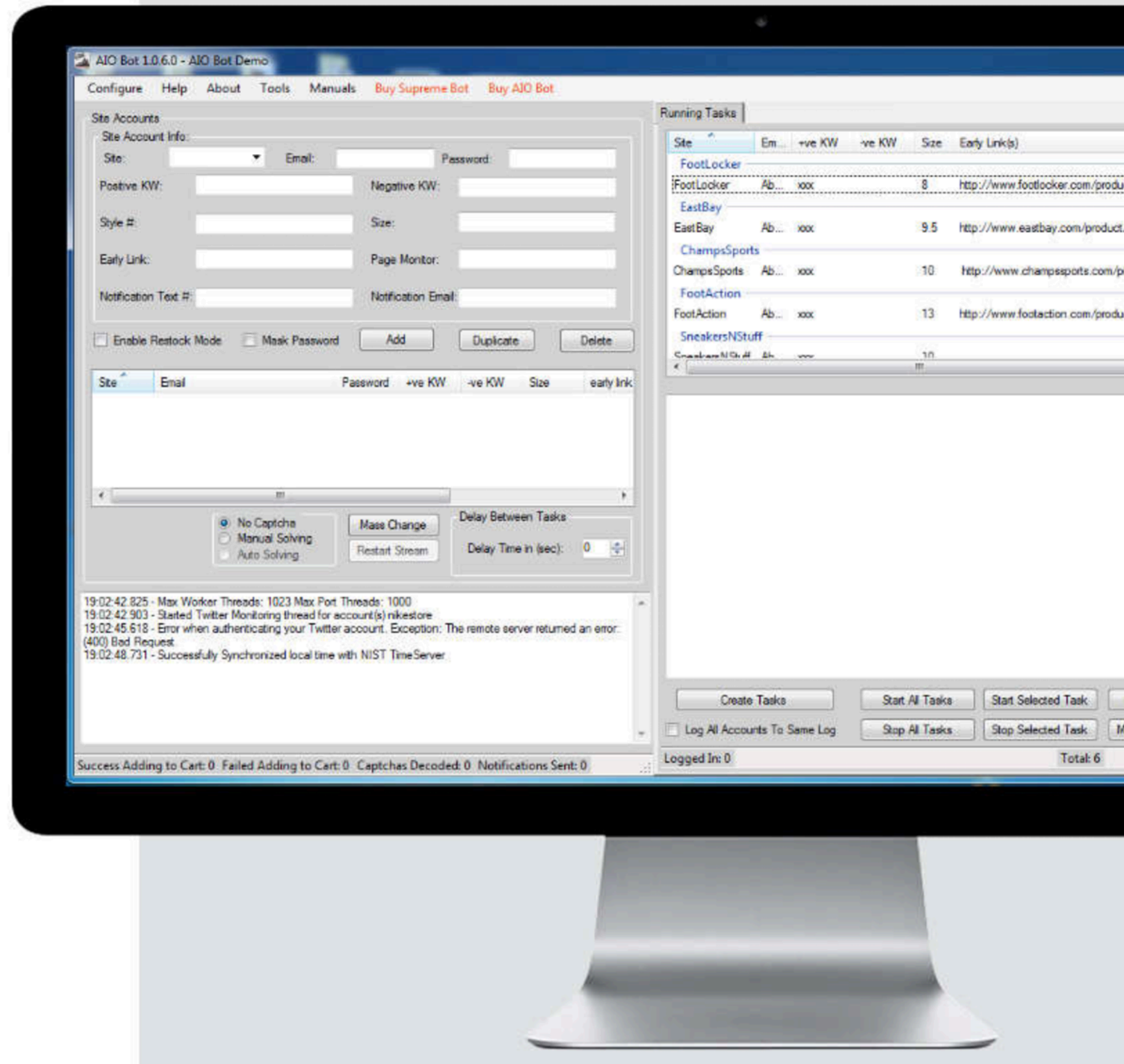

Sneaker Proxies

Sneakers proxies:

Upon assignment, sneakers proxies are checked and guaranteed to work only for the purchased service.

MPP SNEAKERS 20	MPP SNEAKERS 50	MPP SNEAKERS 100	MPP SNEAKERS 250
\$65.00 / pm	\$128.00 / pm	\$242.00 / pm	\$520.00 / pm
Number of proxies 20 22	Number of proxies 50 55	Number of proxies 100 110	Number of proxies 225 250
Multiple locations <input checked="" type="checkbox"/>	Multiple locations <input checked="" type="checkbox"/>	Multiple locations <input checked="" type="checkbox"/>	Multiple locations <input checked="" type="checkbox"/>
Multiple subnets <input checked="" type="checkbox"/>	Multiple subnets <input checked="" type="checkbox"/>	Multiple subnets <input checked="" type="checkbox"/>	Multiple subnets <input checked="" type="checkbox"/>
Monthly randomize Yes	Monthly randomize Yes	Monthly randomize Yes	Monthly randomize Yes
Instant setup Yes	Instant setup Yes	Instant setup Yes	Instant setup Yes
Setup fees No	Setup fees No	Setup fees No	Setup fees No
Price per proxy \$2.95	Price per proxy \$2.32	Price per proxy \$2.20	Price per proxy \$2.05
GET STARTED	GET STARTED	GET STARTED	GET STARTED

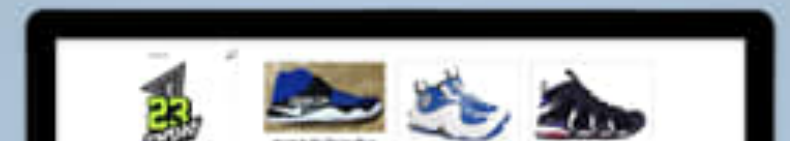
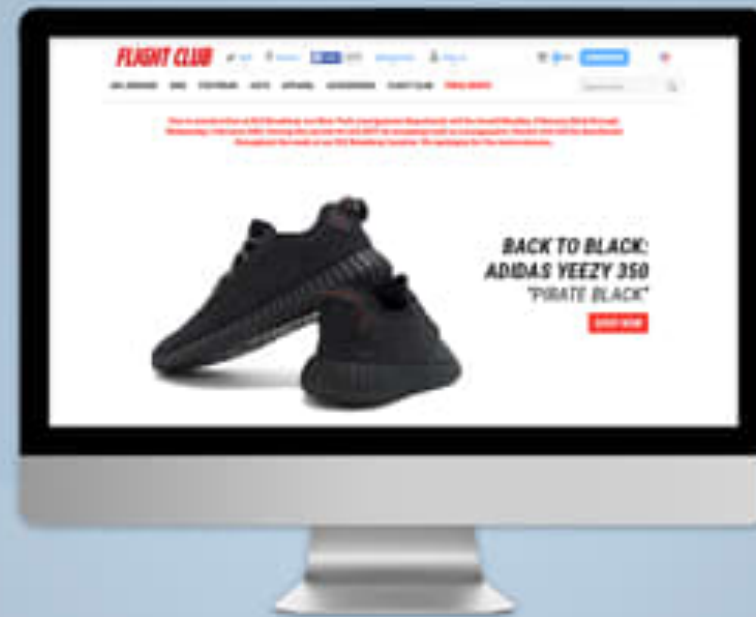
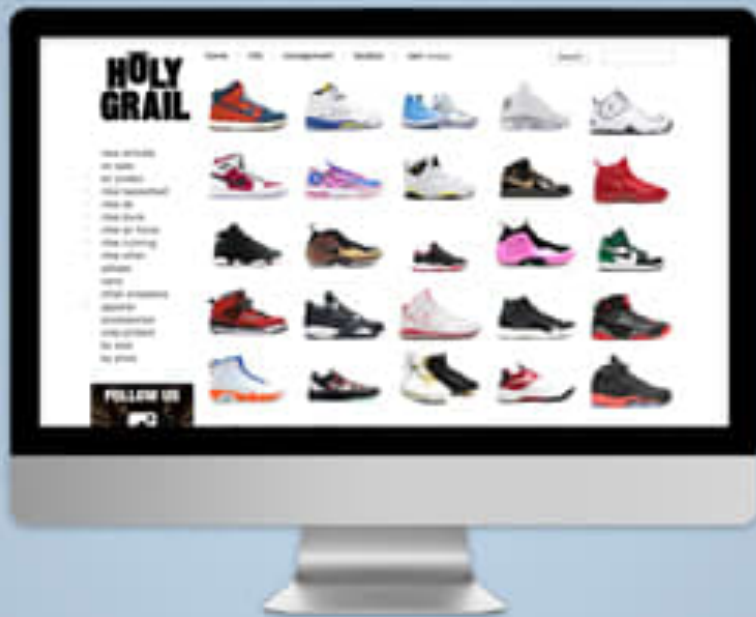
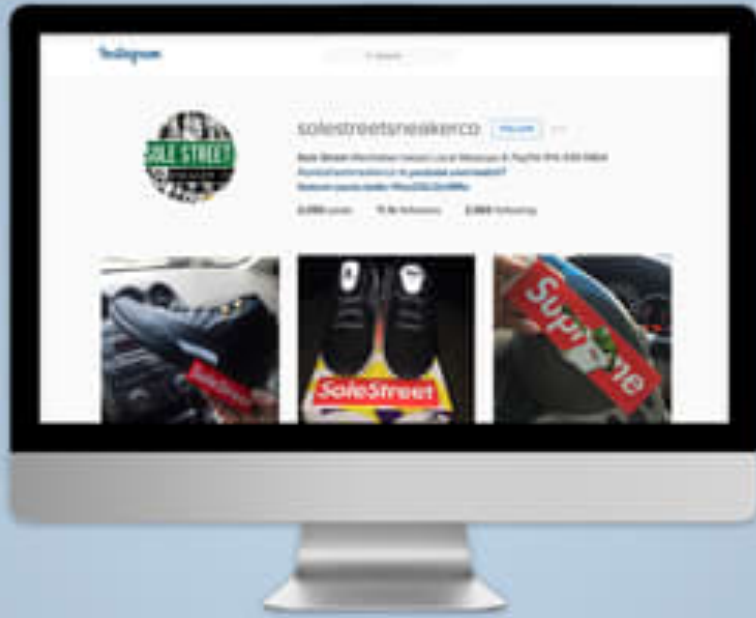

An open source sneaker bot written in Python

172 commits 1 branch 0 releases 6 contributors MIT

Branch: master New pull request Create new file Upload files Find file Clone or download

kfichter	Deleted most scripts in preparation for the project structure change	Latest commit 16d935d on Nov 12, 2016
scripts	Deleted most scripts in preparation for the project structure change	6 months ago
.gitignore	Deleted most scripts in preparation for the project structure change	6 months ago
LICENSE	Should work on python2 (README), and LICENSE.md->LICENSE	11 months ago
README.md	Update README.md	9 months ago
requirements.txt	added requirements.txt	11 months ago

README.md

OpenATC

OpenATC is the first large scale, open source sneaker/ticket/clothing bot project with the potential to target any site.

OpenATC will start by dumping beta scripts.

Installation

OpenATC requires [Python 3](#), but should also work on Python 2.

You'll also need BeautifulSoup4 and requests:

```
$ pip install bs4
$ pip install requests
$ pip install urllib3 --upgrade
```

You may also wish to use the included setup script to fill in your info

```
$ cd Scripts
$ ./makeinfo.py
```

License

OpenATC is licensed under the MIT license.



Why do we care?





Who do we fight?

THE INTERNET OF THINGS

AN EXPLOSION OF CONNECTED POSSIBILITY

BILLIONS OF DEVICES

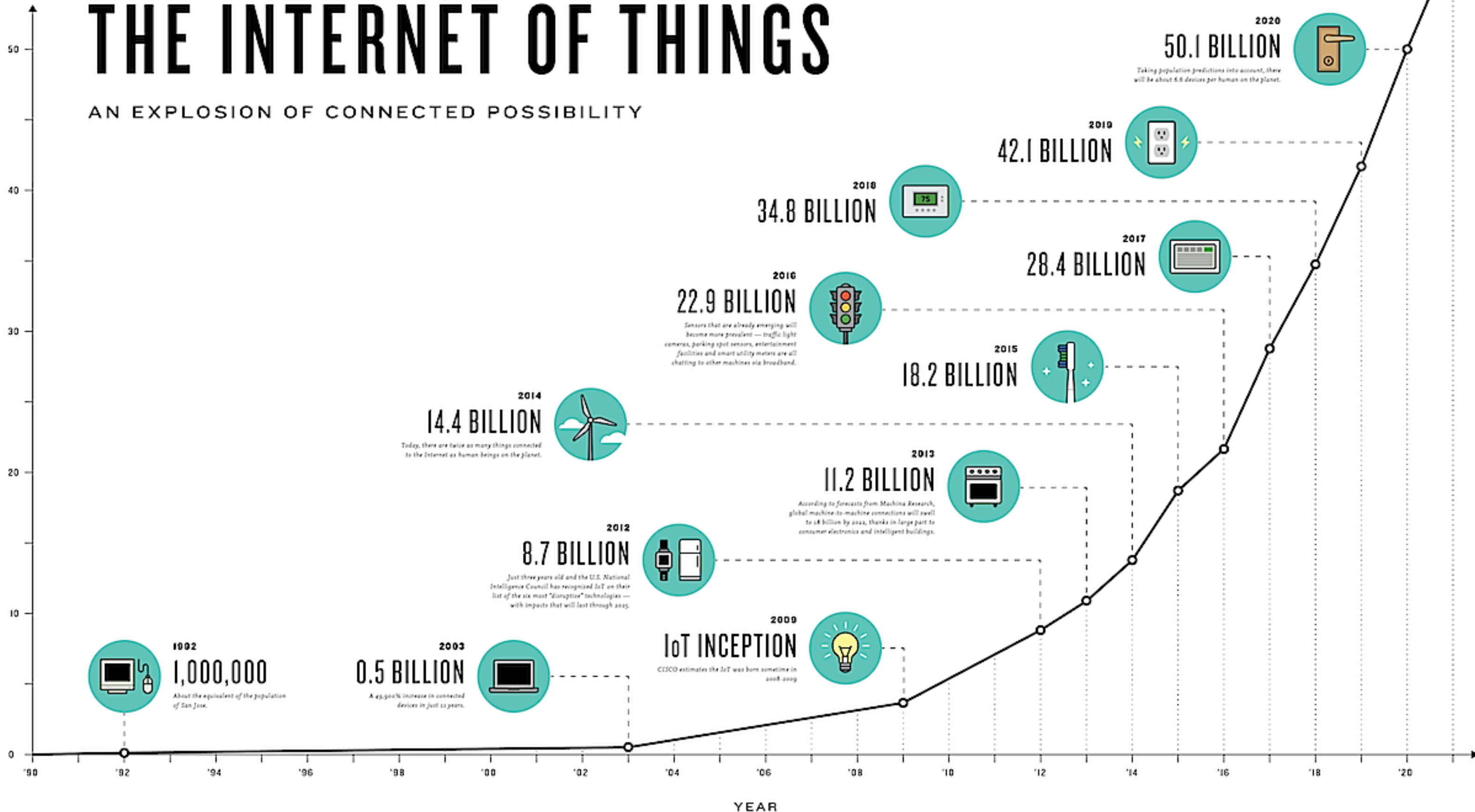









What makes it hard?



How to choose your algorithm?

RULES

1. YOU CAN....

2. YOU CAN'T...

3. YOU CAN....

4. YOU CAN'T

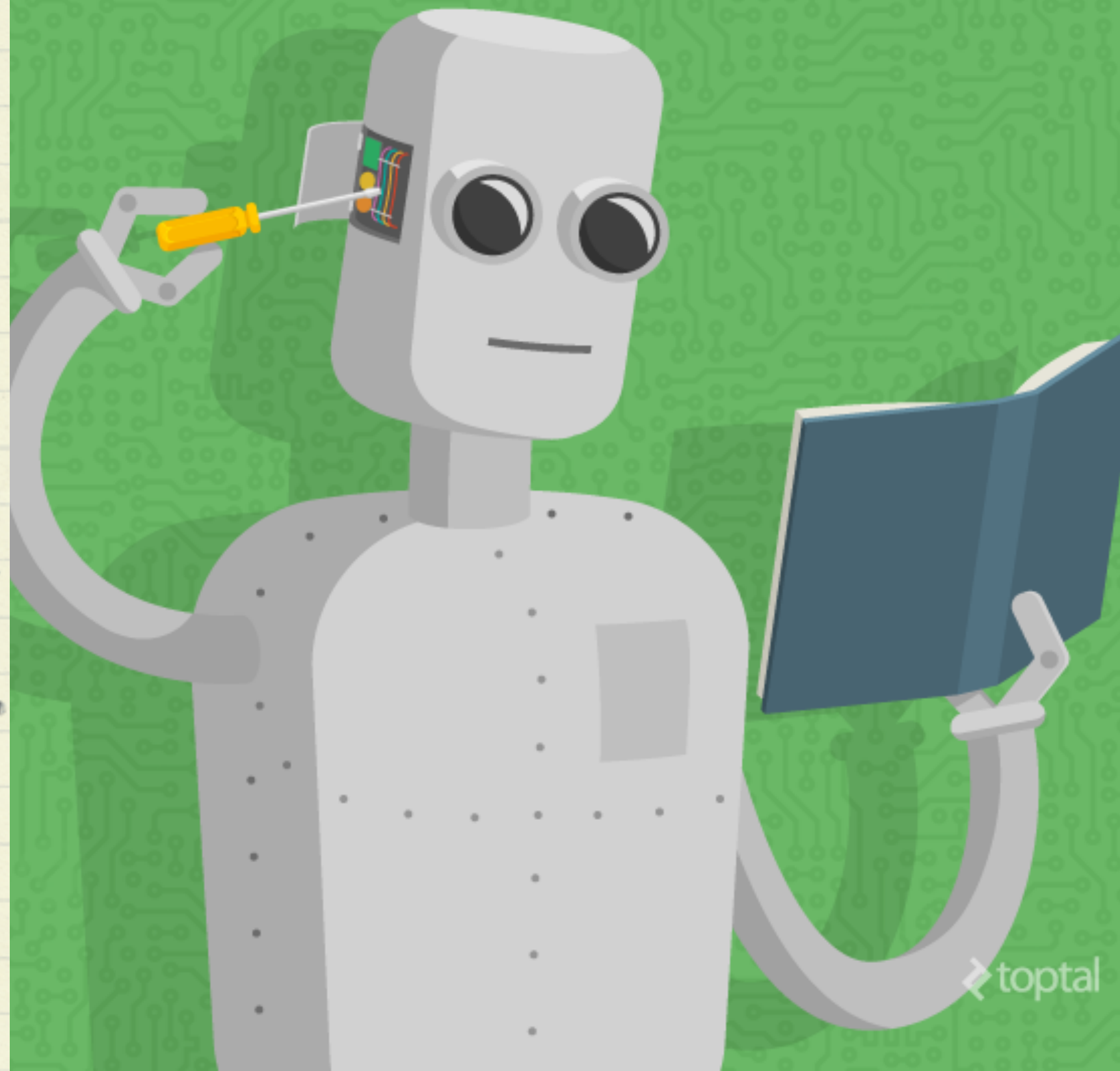

How do you build this?

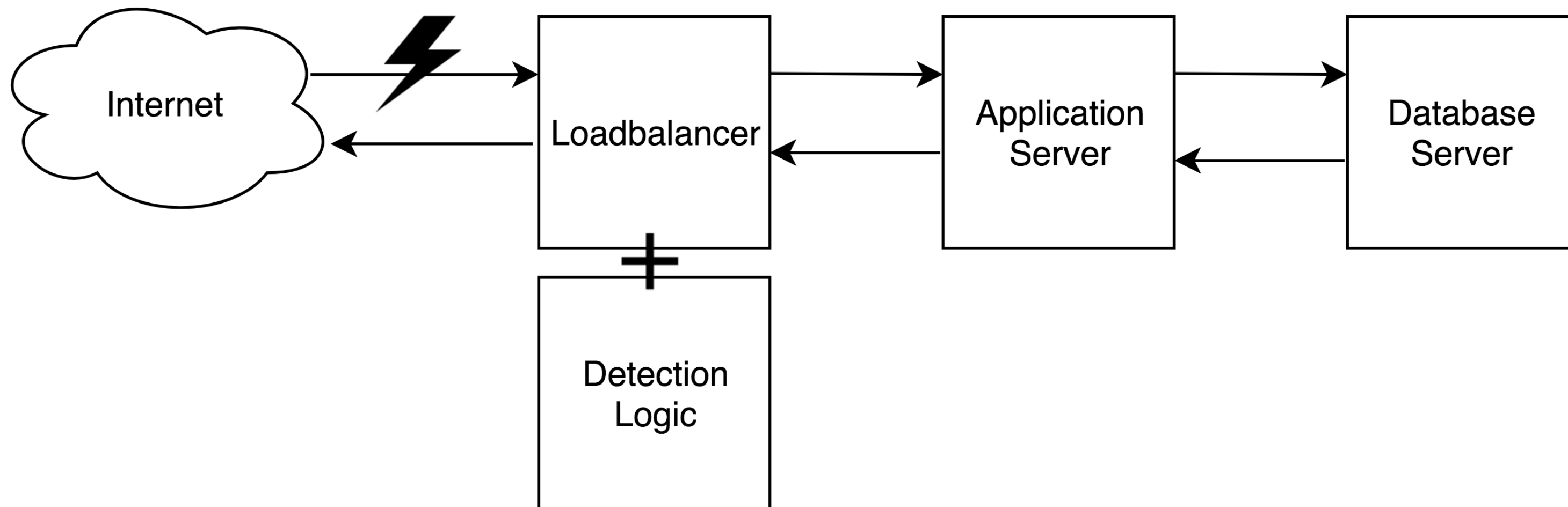

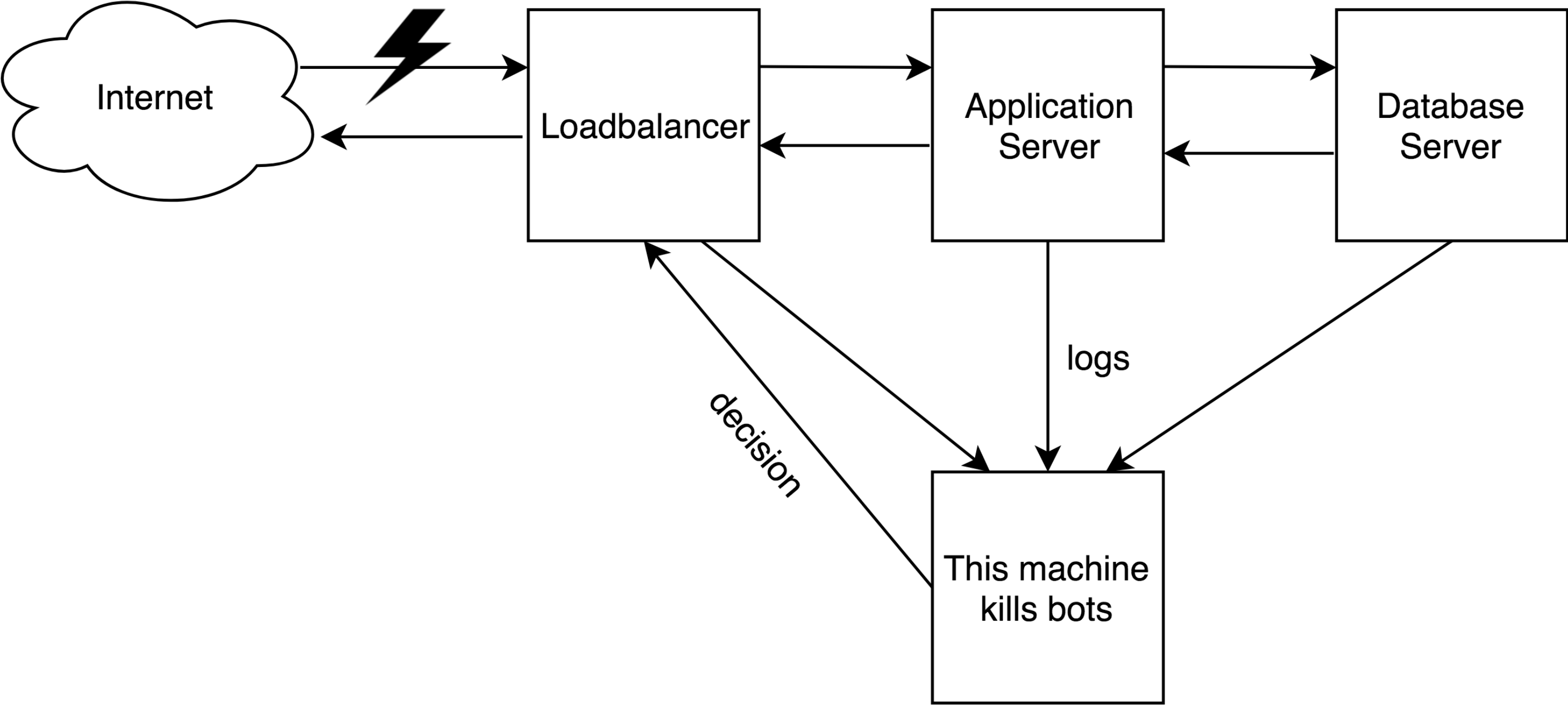

How to identify/cluster users?

127.0.0.1 or fe80::/10



Rules, patterns, vectors



Individual requests



Patterns across an IP address



Patterns across a fingerprint

The background is a complex, abstract pattern of swirling, organic shapes. The colors are primarily light blue, yellow, and orange, with some darker blue and brown tones. The patterns resemble stylized waves, spirals, and flowing lines, creating a sense of movement and depth. The overall effect is a vibrant, textured background.

Patterns across time windows

The easy way



reCAPTCHA™

What to do with bots?



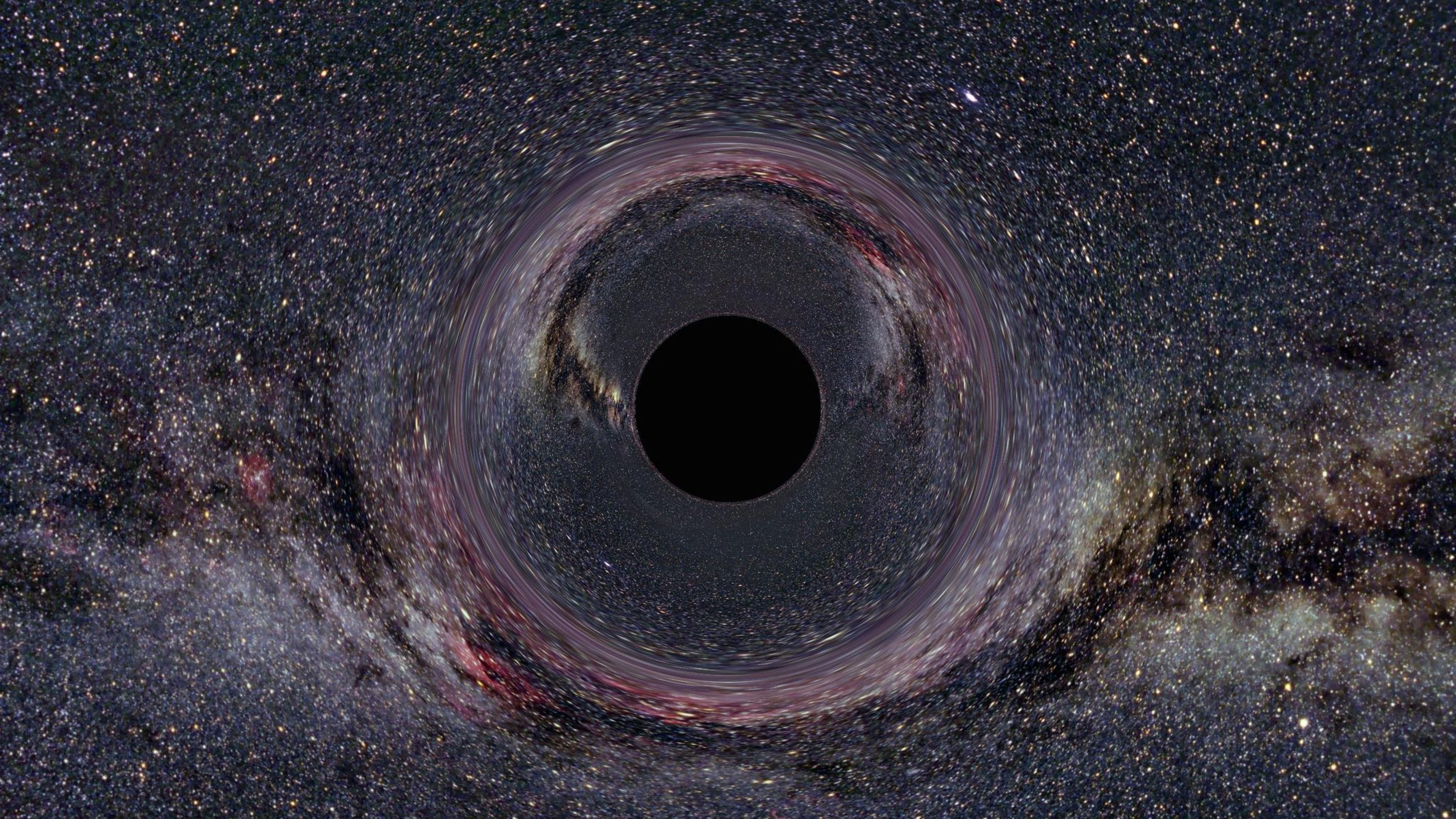











ROAD
CLOSED

ROAD
CLOSED

Results

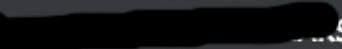

  Today at 11:00 AM
banned
lol

  Today at 11:00 AM
i got banned
WTF
OSS

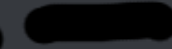
  Today at 11:00 AM
This page is temporarily unavailable because a device from your location is sending large amounts of web requests. Visitors from other locations can still view the page.

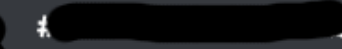
  Today at 11:00 AM
I got banned on a different bot

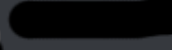

  Today at 11:00 AM
No proxies

  Today at 11:01 AM
wtf L str away gone

  Today at 11:01 AM
soft banned

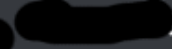
  Today at 11:01 AM
rip

  Today at 11:01 AM
lol

  Today at 11:01 AM
same



Rule matches

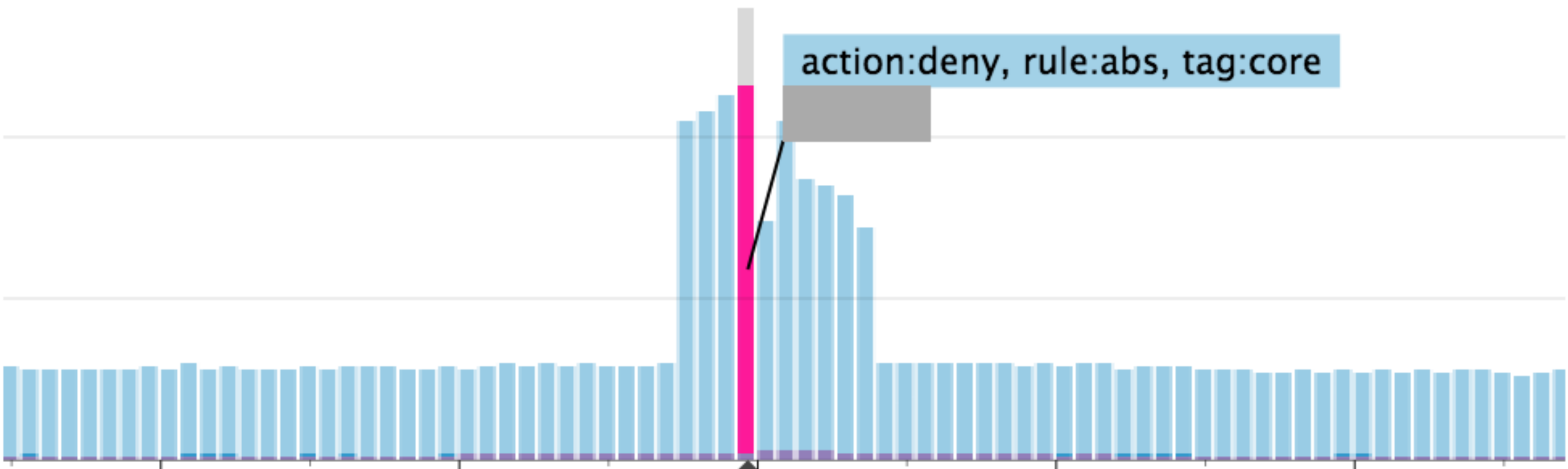

action:deny, rule:abs, tag:core

1m @ 12:29:00

12:00

12:15

12:45

13:00

Testimonies



Katrina Verey ● @knverey
Developer - Cloud Platform
☀️

“When I was IMOC, I didn't notice the DDoS. Which is great, because IMOC not noticing means no incident!”



Jordan Wheeler ● @jordan
Databases

“Now, we just don't get paged in the first place for replication lag during flash sales! No more manual splunking for bots and shackling them.”



Questions

Image sources

<https://www.flowmon.com/getattachment/c0b57e7c-b907-4e53-838c-747dcea0a250/Intracloud-DDoS-detection-and-mitigation-using-SDN.aspx>
<http://people.com/sports/sneakers-sushi-actually-its-both-check-out-the-amazing-photos/>
<http://www.highsnobiety.com/2016/04/27/sneaker-bots-how-do-they-work/>
<http://ca.complex.com/sneakers/2016/03/best-sneaker-reseller-sites>
http://www.dccomics.com/sites/default/files/GalleryChar_1900x900_JusticeLeague_52ab8e54d0a6f0.42170553.jpg
<http://www.avclub.com/article/heres-what-fight-club-looks-like-without-tyler-dur-107125>
<http://hightechforum.org/wp-content/uploads/2015/11/IoT-Chart.png>
<http://zdnet3.cbsstatic.com/hub/i/r/2015/12/19/983c50ba-d4e9-4bdc-8cd8-d713a3aa5943/resize/1170x878/d8b5b76108ba0f141e2526d815ff315f/r2d2.jpg>
http://assets2.ignimgs.com/2016/01/20/terminatorgenesis1280jpg-c73cd0_1280w.jpg
<http://i0.wp.com/tctthirdculture.com/wp-content/uploads/2016/10/GitS-2.jpg>
<https://s-media-cache-ak0.pinimg.com/originals/bf/ee/f3/bfeef3a2fddc208f6059a0c004d59aff.jpg>
<http://4.bp.blogspot.com/D8oSVOCeyE8/S91q3Ps4yAI/AAAAAAAAABvU/eQ9i5vkgENw/s1600/rules16681668.gif>
<https://uploads.toptal.io/blog/image/443/toptal-blog-image-1407508081138.png>
<http://www.pngall.com/wp-content/uploads/2016/06/Fingerprint-Free-Download-PNG.png>
<https://s-media-cache-ak0.pinimg.com/originals/f7/16/07/f71607e66c38e2934173e2d30b3b0a74.jpg>
<http://www.tim-comstock.com/wp-content/uploads/2016/04/patterns-02.jpg>
<http://wallpaper-gallery.net/images/colorful-computer-wallpaper/colorful-computer-wallpaper-23.jpg>
<https://s-media-cache-ak0.pinimg.com/originals/64/d6/ff/64d6ffe72f4f090b07ee2b1caacacbd0.jpg>
<https://i.ytimg.com/vi/WqnXp6Saa8Y/maxresdefault.jpg>
<http://d.ibtimes.co.uk/en/full/1473395/pygmy-slow-loris.jpg>
https://www-tc.pbs.org/wgbh/nova/next/wp-content/uploads/2015/07/BlackHole_Milkyway.jpg
<http://www.guoguiyan.com/data/out/98/69040440-honeycomb-wallpapers.jpg>
<https://i.ytimg.com/vi/QJ0yb4b58DI/maxresdefault.jpg>
<http://1.bp.blogspot.com/-9A-WAjLWR2U/U9qfflVKAI/AAAAAAAAAKTY/yT9CcuAyNvo/s1600/landfill.jpg>
<http://watchdog.org/wp-content/blogs.dir/1/files/2014/09/RoadBlock.jpg>